



LED Tube Specification

T5 led tube light:



Item No.	Working Voltage	Power	Size (mm)	Nos.of led	Color Temperature	Luminous Efficiency (Frosted)	PF	CRI	Warranty
T5-0.6m-A2-10W	AC90V-265V	10W	L600*Φ23	48	2700K-6500K	1000-1050lm	≥0.9	80	3 years
T5-0.9m-A2-14W	AC90V-265V	14W	L900*Φ23	72	2700K-6500K	1400-1470lm	≥0.9	80	3 years
T5-1.2m-A2-18W	AC90V-265V	18W	L1200*Φ23	96	2700K-6500K	1800-1890lm	≥0.9	80	3 years
T5-1.5m-A2-22W	AC90V-265V	22W	L1500*Φ23	120	2700K-6500K	2200-2310lm	≥0.9	80	3 years

LED Tube Light

T8 led tube light:



Product Features

Internal Non-isolated power supply, High Power Factor more than 0.9.

Use the high quality aluminum PCB for LED's better heat dissipation.

High-grade PC cover -light transmittance (>95%), Transparent PC cover and frosted PC cover are available.

High Light Efficiency up to 90lm/w.

Lamp Material Available: AL+PC

3 Years Warranty

Specification



T8-SMD2835(AL+PC)

Item No.	Working Voltage	Power	Size (mm)	Nos.of led	Color Temperature	Efficiency (Frosted)	PF	CRI	Warranty
T8-0.6m-A2-10W	AC100V-265V	10W	L588*Φ26	48	2700K-6500K	100lm/w	≥0.9	80	3 years
T8-0.9m-A2-14W	AC100V-265V	14W	L892*Φ26	68	2700K-6500K	100lm/w	≥0.9	80	3 years
T8-1.2m-A2-18W	AC100V-265V	18W	L1198*Φ26	96	2700K-6500K	100lm/w	≥0.9	80	3 years
T8-1.5m-A2-22W	AC100V-265V	22W	L1498*Φ26	120	2700K-6500K	100lm/w	≥0.9	80	3 years

LED Tube Light

Item No.	Working Voltage	Power	Size (mm)	Nos.of led	Color Temperature	PF	CRI	Warranty
T8-0.6m-B-10W	AC185-265v	10W	L588*Φ26	48	2700K-6500K	≥0.6	80	2 year
T8-0.9m-B-14W	AC185-265v	14w	L892*Φ26	72	2700K-6500K	≥0.6	80	2 year
T8-1.2m-B-18W	AC185-265v	18W	L1198*Φ26	96	2700K-6500K	≥0.6	80	2 year
T8-1.5m-B-22W	AC185-265v	22W	L1198*Φ26	120	2700K-6500K	≥0.6	80	2 year



T8-V(AL+PC)

Item No.	Working Voltage	Power	Size (mm)	Nos.of led	Color Temperature	Efficiency (Transparent cover)	PF	CRI	Warranty
T8-0.6m-VY-18W	AC85-265V	18W	Φ30*L600	96	3000-3200K/ 4000-4500K/ 6000-6500K	100-110lm/w	≥0.95	80	3 years
T8-0.9m-VY-28W	AC85-265V	28W	Φ30*L900	140		100-110lm/w	≥0.95	80	3 years
T8-1.2m-VY-36W	AC85-265V	36W	Φ30*L1200	192		100-110lm/w	≥0.95	80	3 years
T8-1.2m-VY-48W	AC85-265V	48w	Φ30*L1200	240		100-110lm/w	≥0.95	80	3 years
T8-1.5m-VY-48W	AC85-265V	48W	Φ30*L1500	240		100-110lm/w	≥0.95	80	3 years
T8-1.5m-VY-60W	AC85-265V	60W	Φ30*L1500	288		100-110lm/w	≥0.95	80	3 years
T8-1.8m-VY-56W	AC85-265V	56W	Φ30*1800	288		100-110lm/w	≥0.95	80	3 years
T8-2.4m-VY-36W	AC85-265V	36W	Φ30*2400	192		100-110lm/w	≥0.95	80	3 years
T8-2.4m-VY-72W	AC85-265V	72W	Φ30*2400	384		100-110lm/w	≥0.95	80	3 years

LED Tube Light



T8-SMD2835(Plastic & Glass)

D3-class(Glass)

Item No.	Working Voltage	Power	Size (mm)	Nos.of led	Color Temperature	PF	CRI	Warranty
T8-0.6m-D3-9W	AC170V-260V	9W	L588*Φ26	48	2700K-6500K	≥0.5	70	2 years
T8-0.9m-D3-14W	AC170V-260V	14w	L893*Φ26	72	2700K-6500K	≥0.5	70	2 years
T8-1.2m-D3-18W	AC170V-260V	18W	L1198*Φ26	96	2700K-6500K	≥0.5	70	2 years

D1-class(Plastic)

Item No.	Working Voltage	Power	Size (mm)	Nos.of led	Color Temperature	PF	CRI	Warranty
T8-0.6m-D1-9W	AC170V-260V	9W	L588*Φ26	48	2700K-6500K	≥0.5	70	2 years
T8-0.9m-D1-14W	AC170V-260V	9W	L893*Φ26	72	2700K-6500K	≥0.5	70	2 years
T8-1.2m-D1-18W	AC170V-260V	18W	L1198*Φ26	96	2700K-6500K	≥0.5	70	2 years

Testing Report

Light SpectroPhotoColorMeter Analysis Report

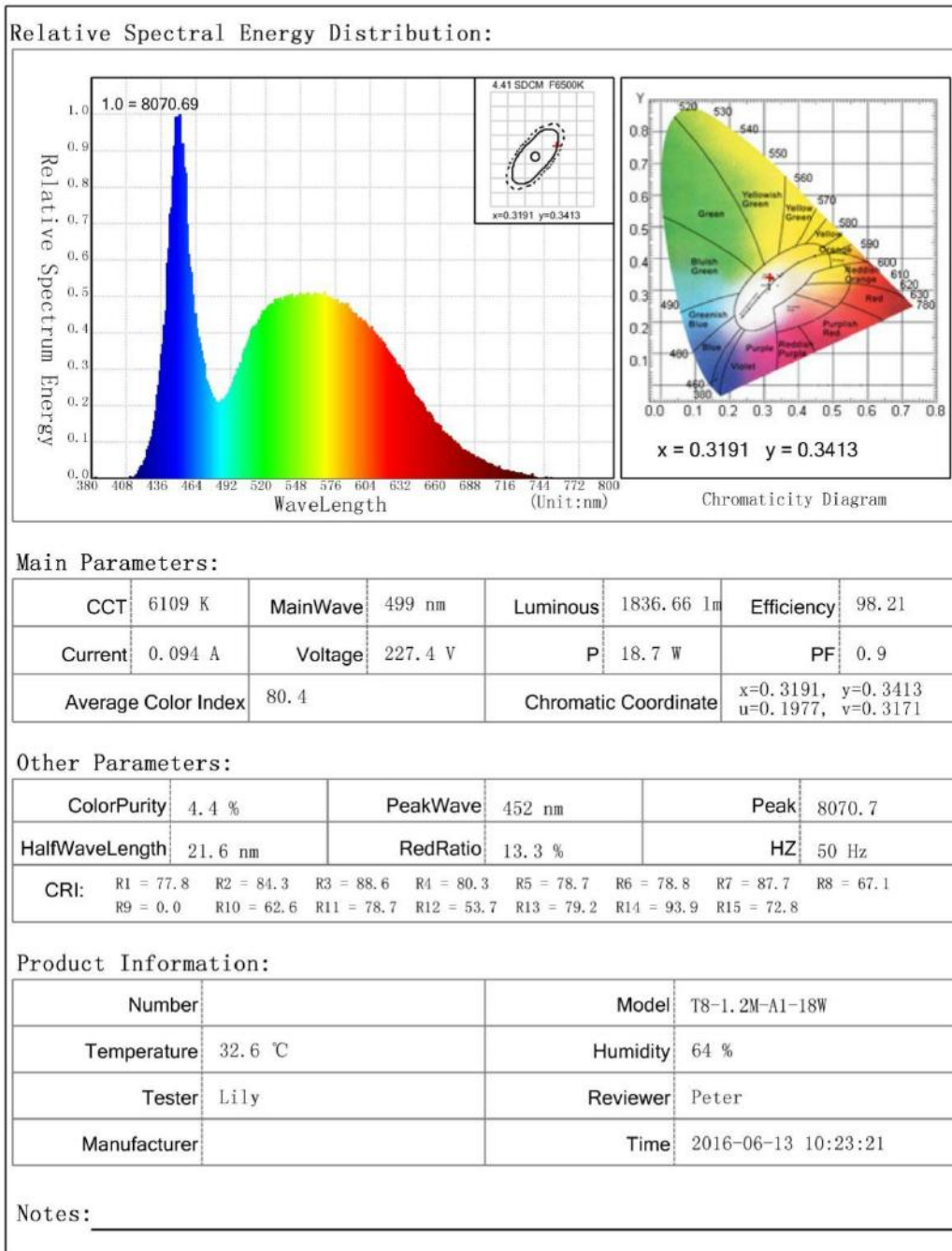

LED Tube Light

Dimensions

Model	Spec(mm)	A(mm)	B(mm)	C(mm)	D(mm)
T8-0.6m	L588*Φ26	588	605	26	15
T8-0.9m	L892*Φ26	892	907	26	15
T8-1.2m	L1198*Φ26	1198	1215	26	15
T8-1.5m	L1498*Φ26	1498	1513	26	15



Installation

Installation of One Side Power in Tube:



For Lamp Holder with Magnetic Ballast & Starter:

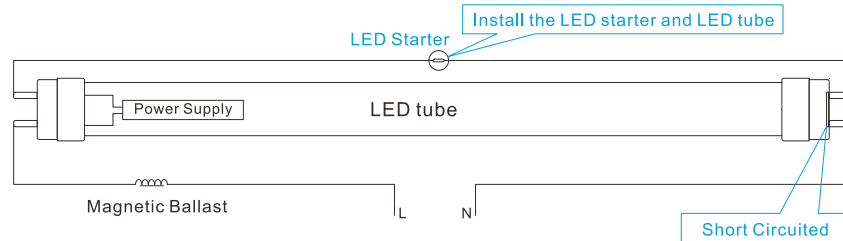

For Lamp Holder with Electrical Ballast:

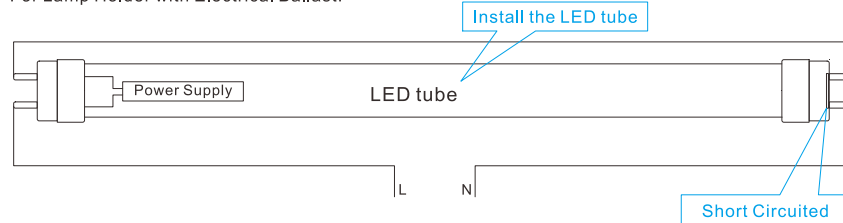

Installation of Both Sides Power in Tube:

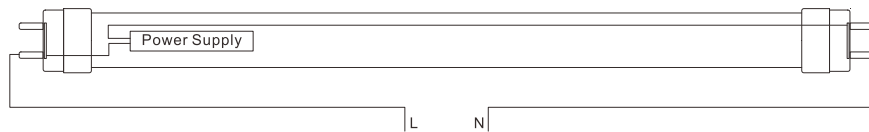

For Lamp Holder with Magnetic Ballast & Starter:

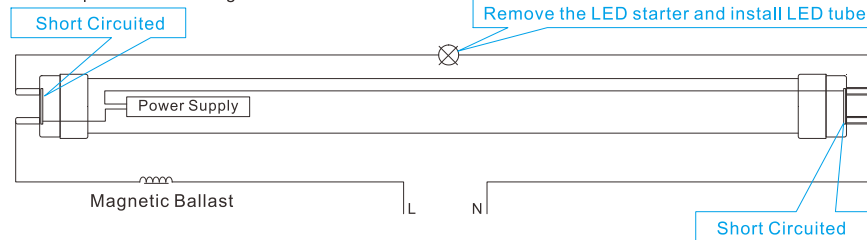

For Lamp Holder with Electrical Ballast:

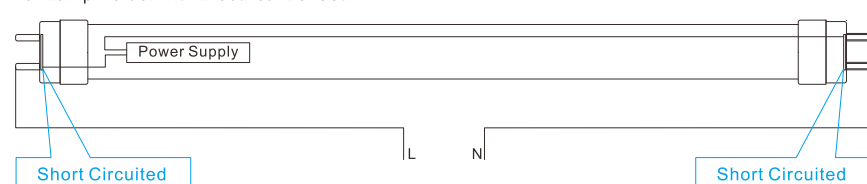

LED Tube Light

Packing Info

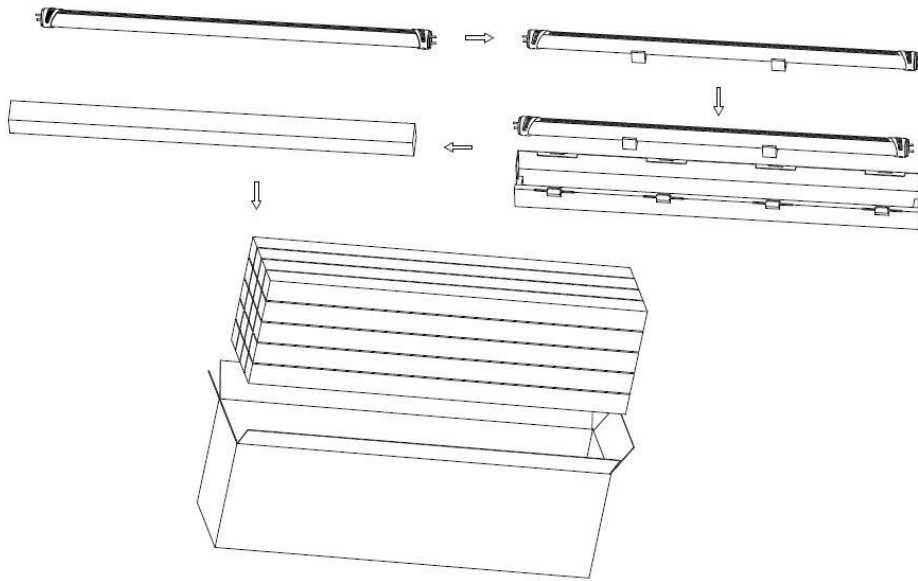

Model	Carton Size	Q'ty/CTN	GW./CTN
T8-0.6m	65*23*23mm	25	5.5kg
T8-0.9m	94*23*22mm	25	8.8kg
T8-1.2m	125*23*22mm	25	12.5kg
T8-1.5m	154*22*24mm	25	14.8kg